

Aalborg Trivakbaner.
Projekteret Kemise.

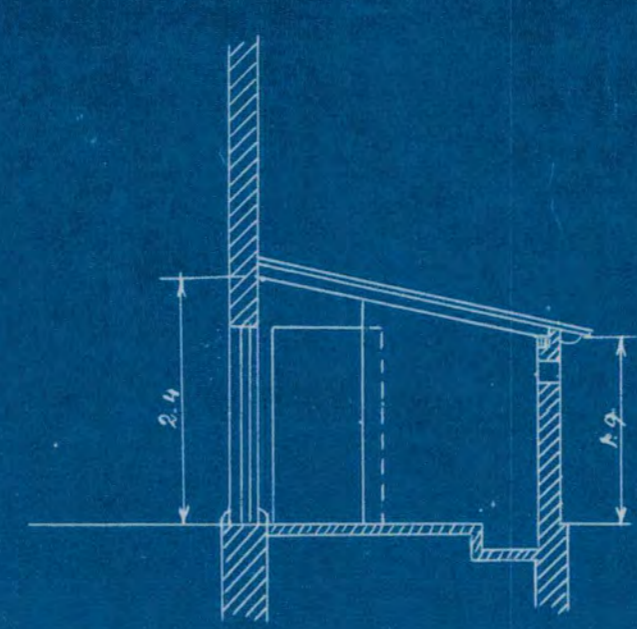

Facade.

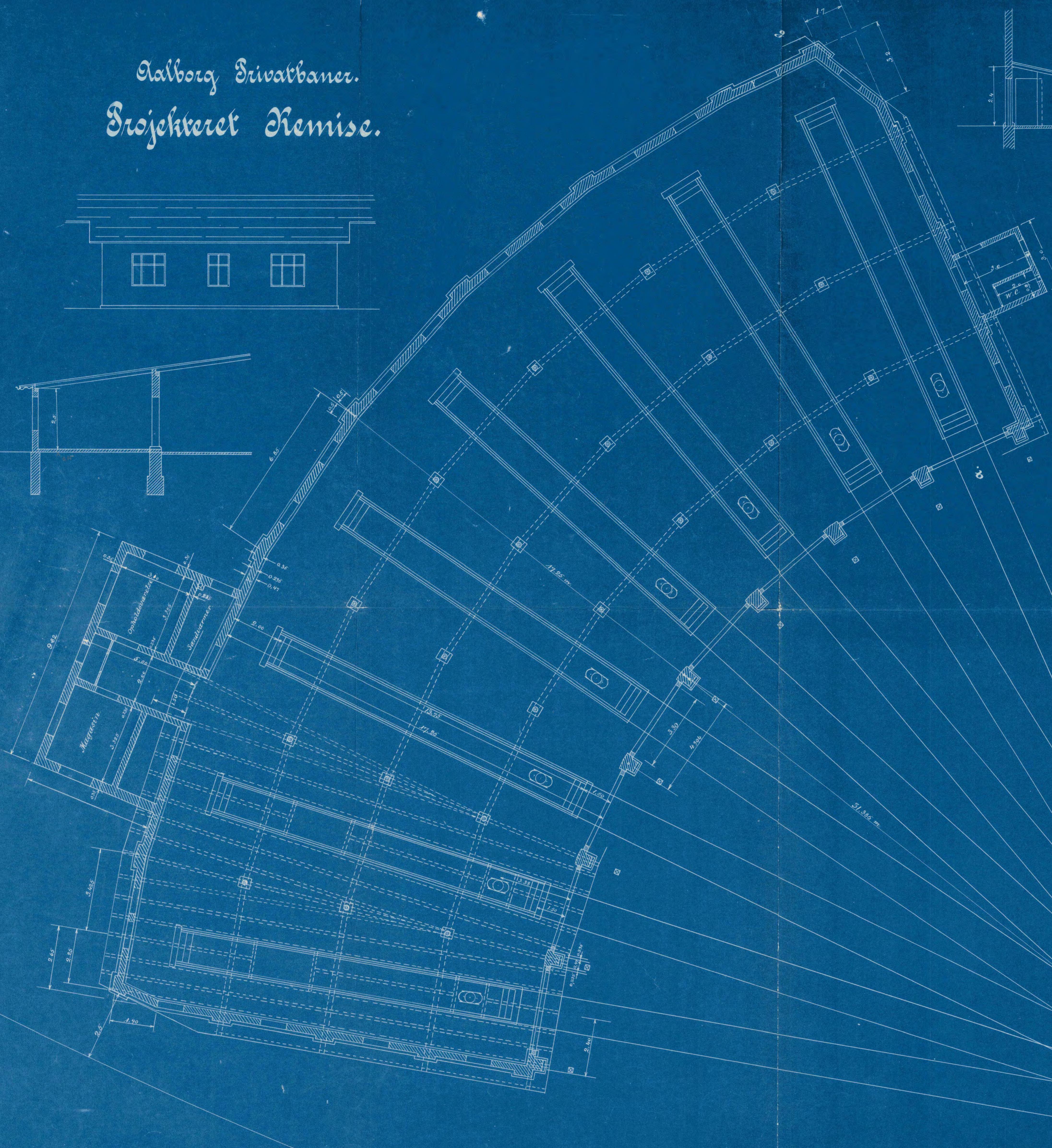
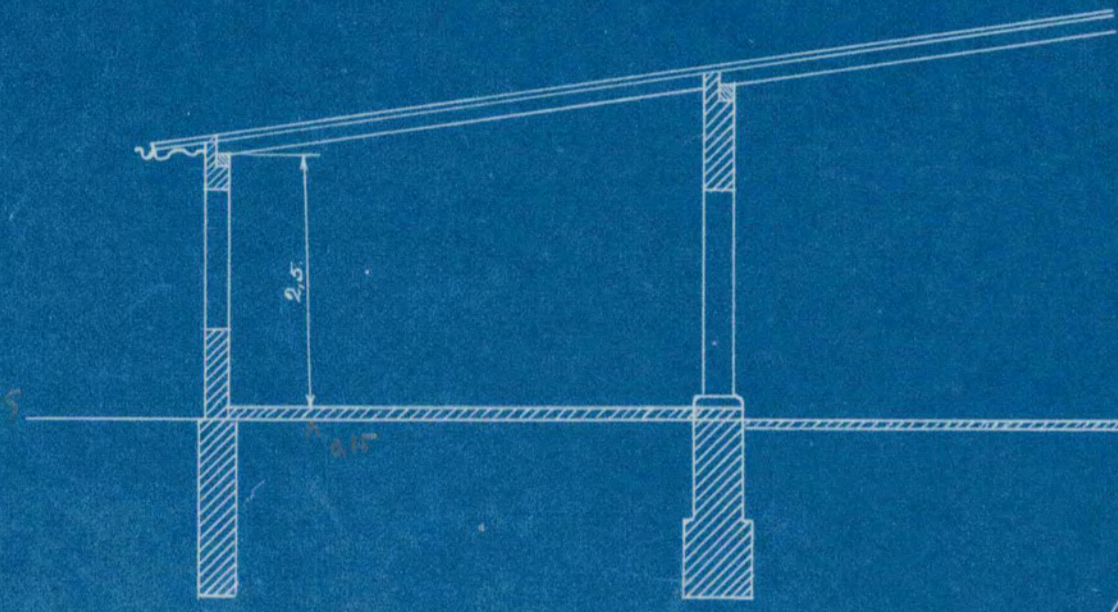
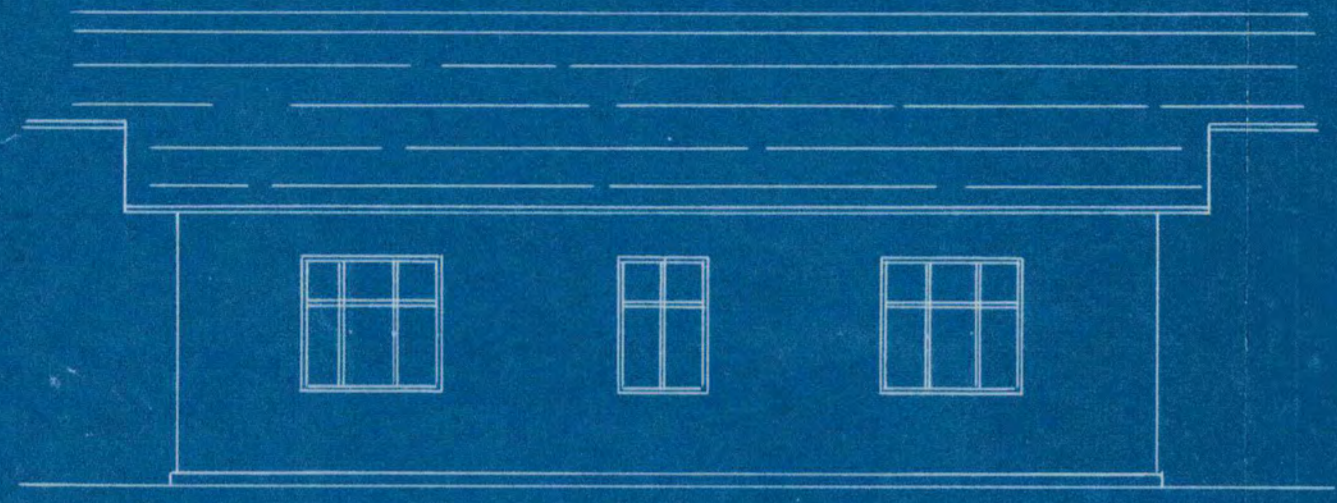

Der anbringes 1 Dør i hveranden Port.

Snit a-b.

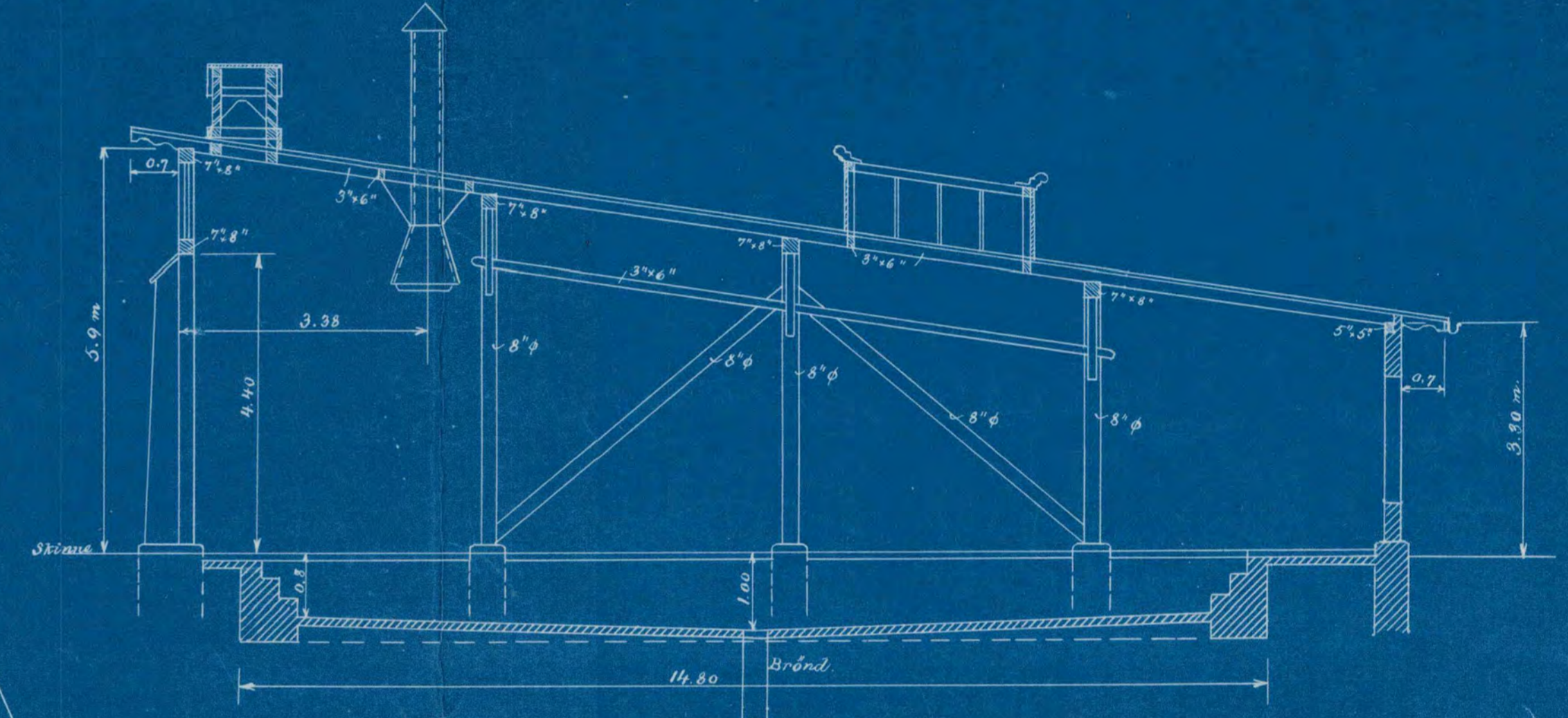

Gavl.

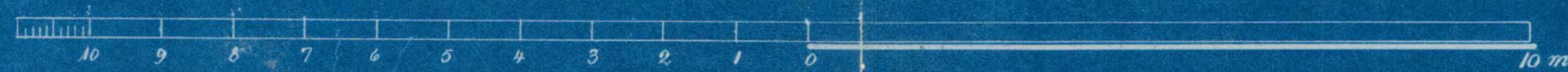

Aalborg Privatbaner.
 Projekteret Kemise.

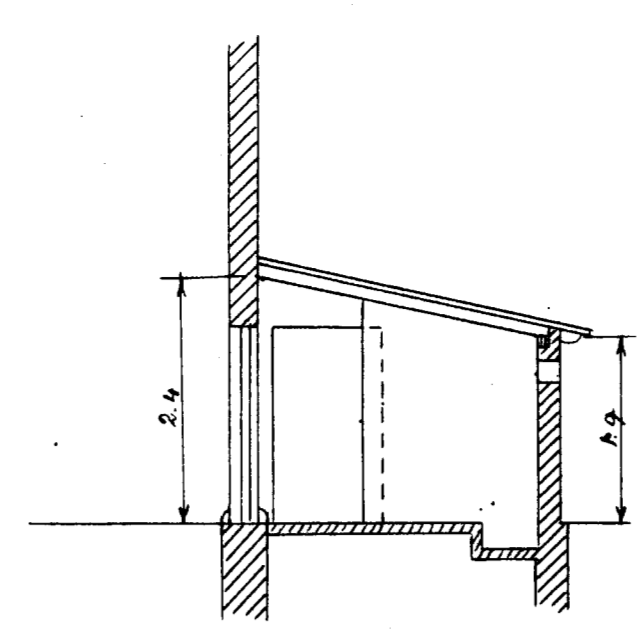
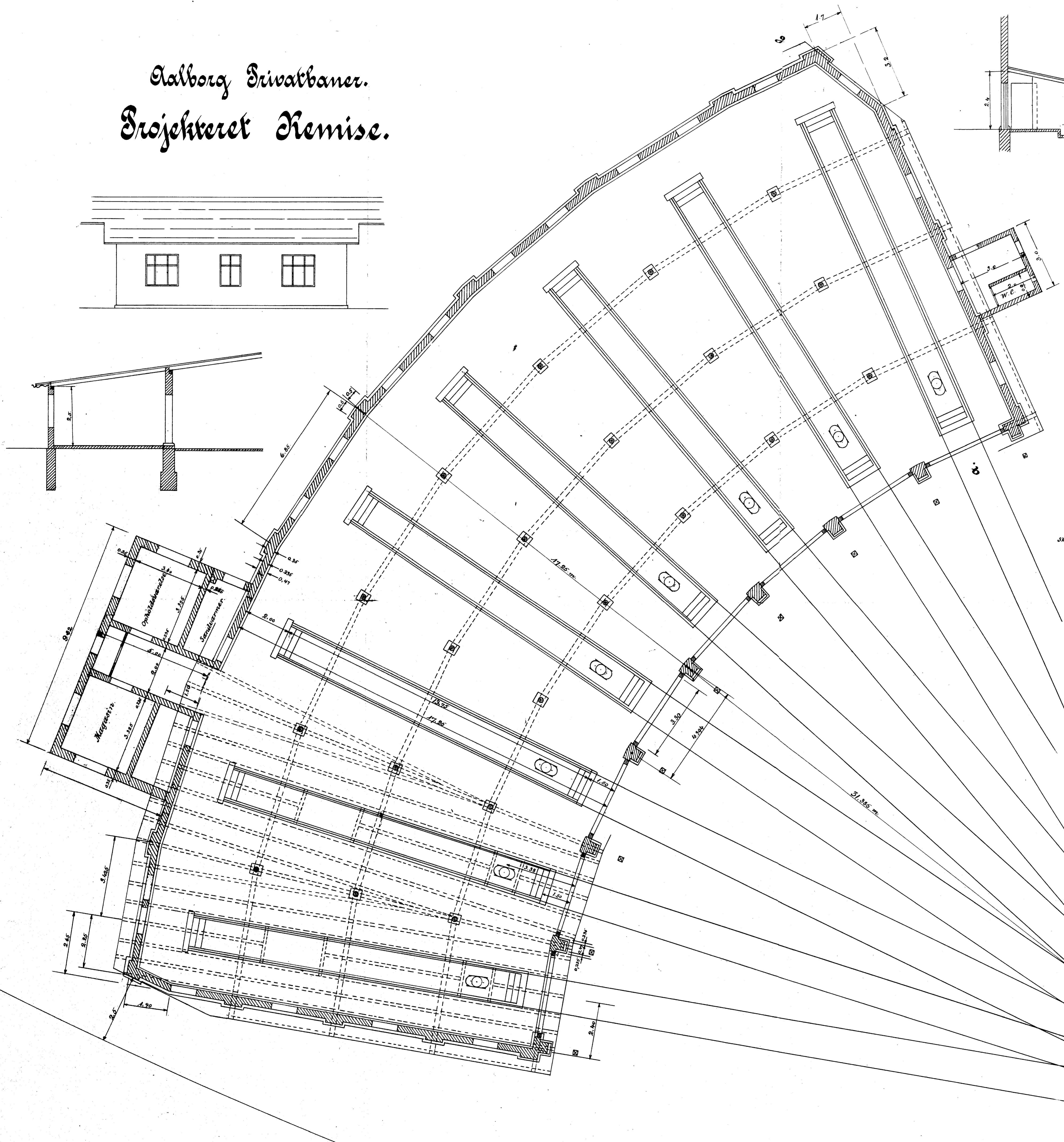
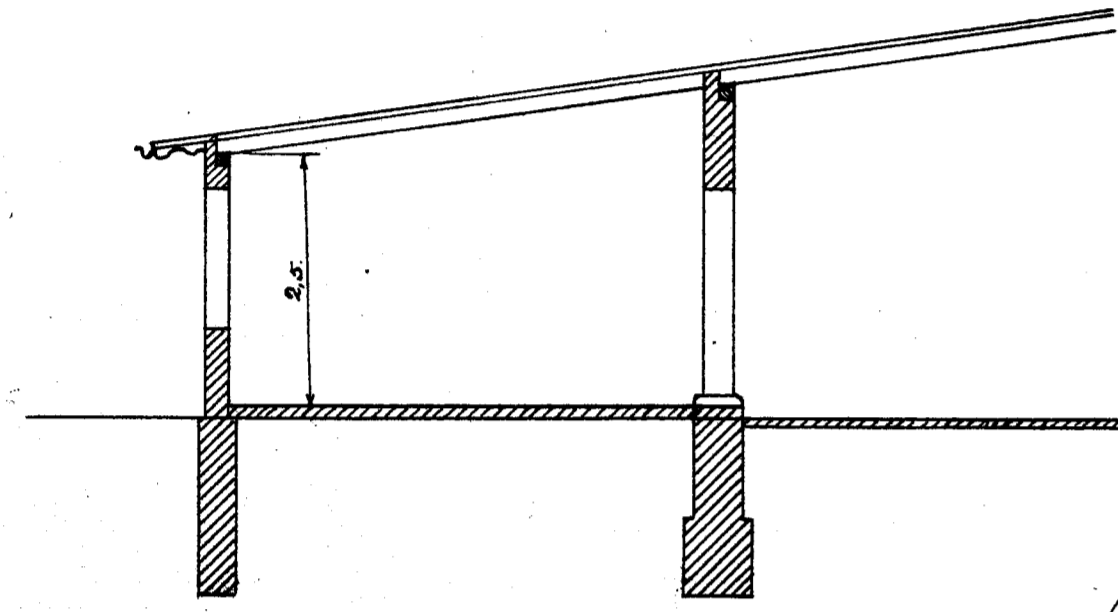
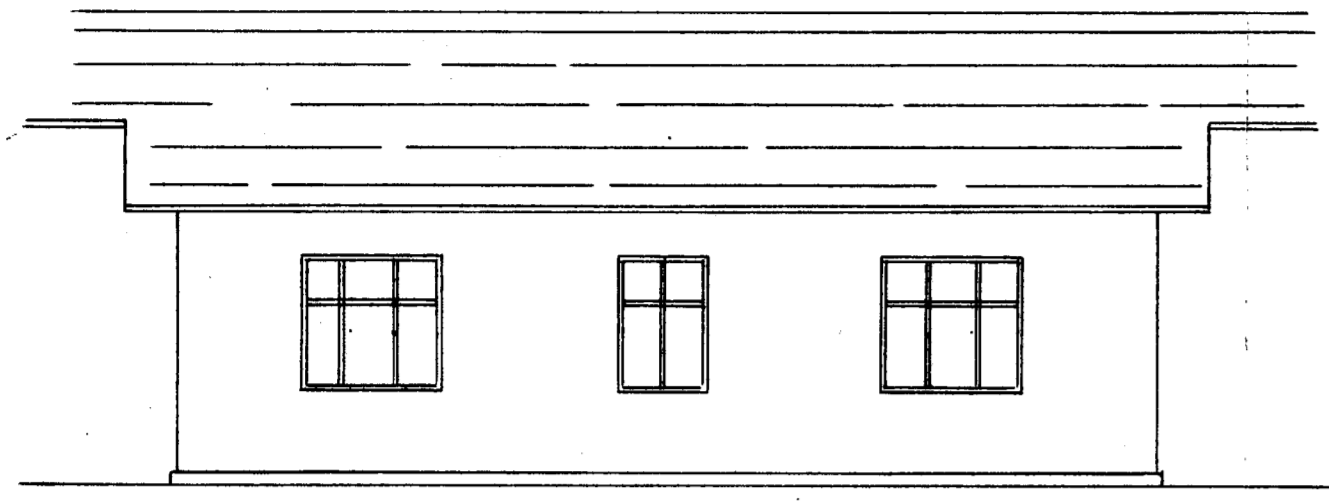

Facade.

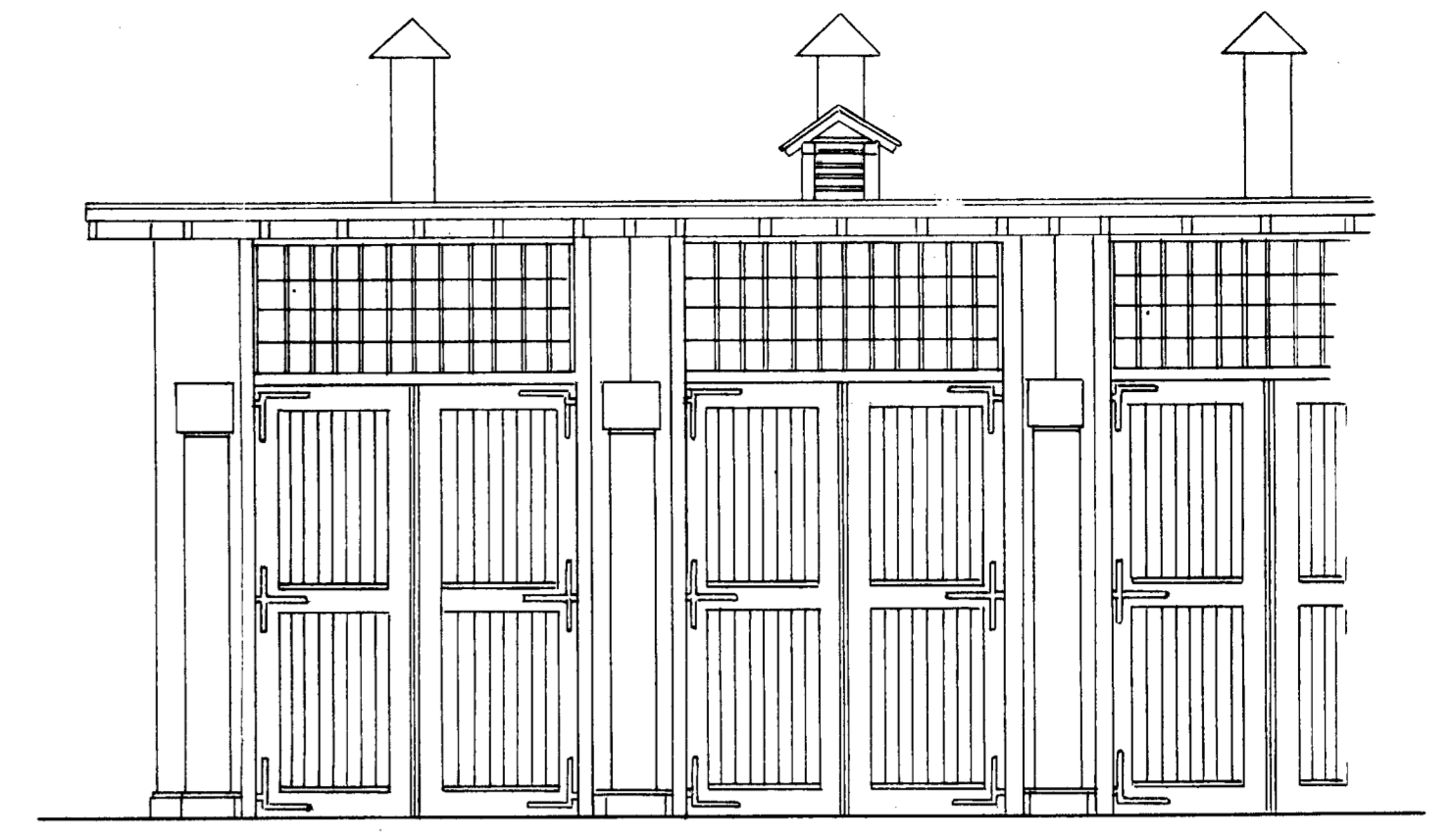

Der anbringes 1 Dør i hveranden Port.

Snit a-b.

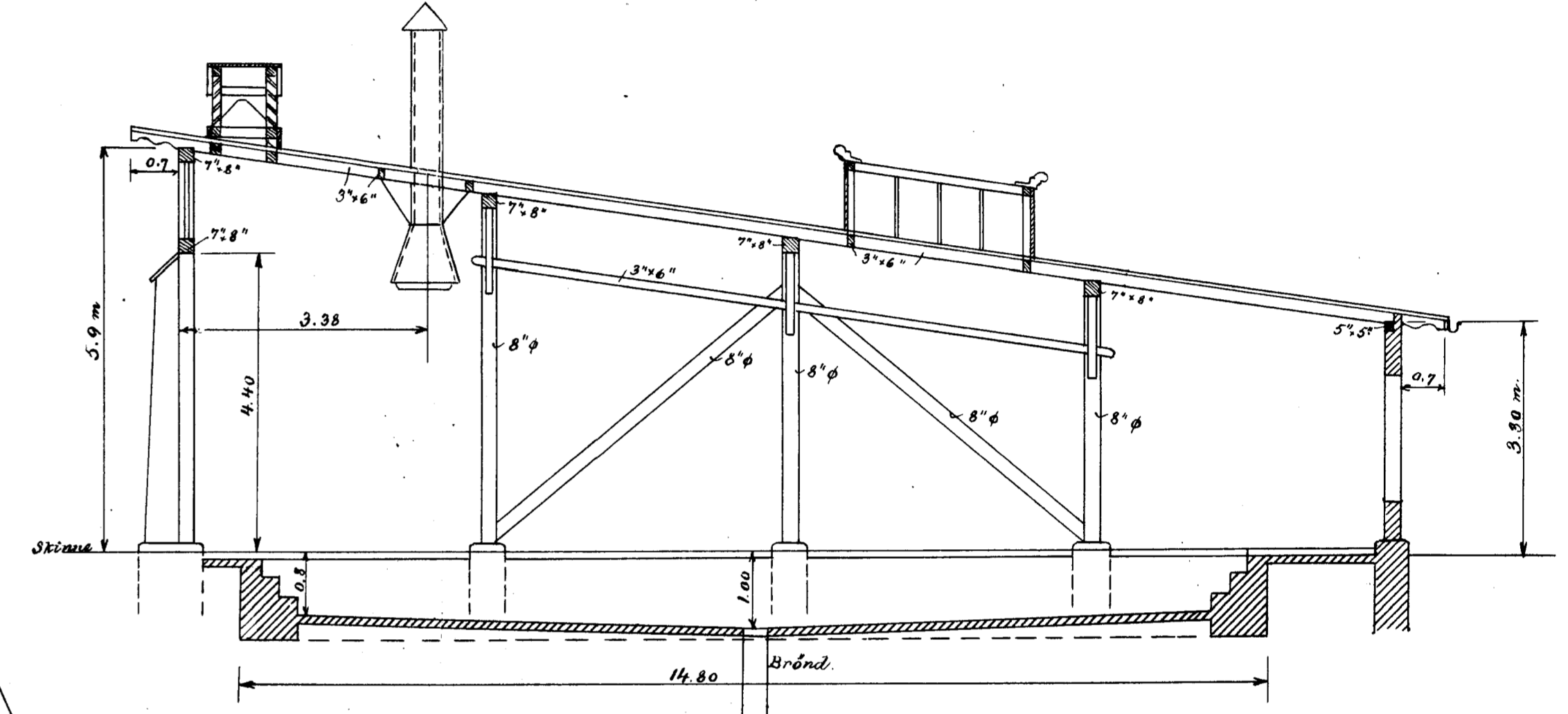

Gavl.

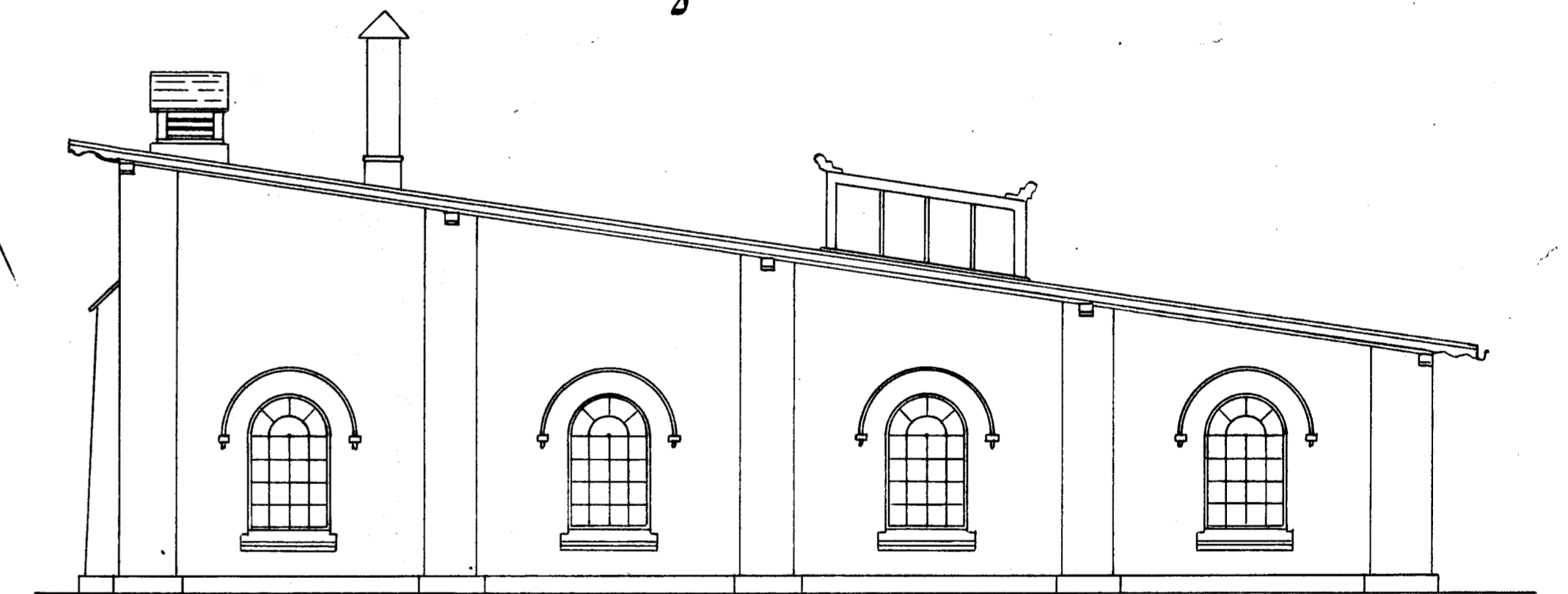

1:75.

